

# 硬质合金工程刀具

Carbide cutting tools for civil construction

桩机工程刀具/盾构刀具/矿山刀具/其他硬质合金工程刀具

QINGDAO KAMOF ELECTRIC CO., LTD

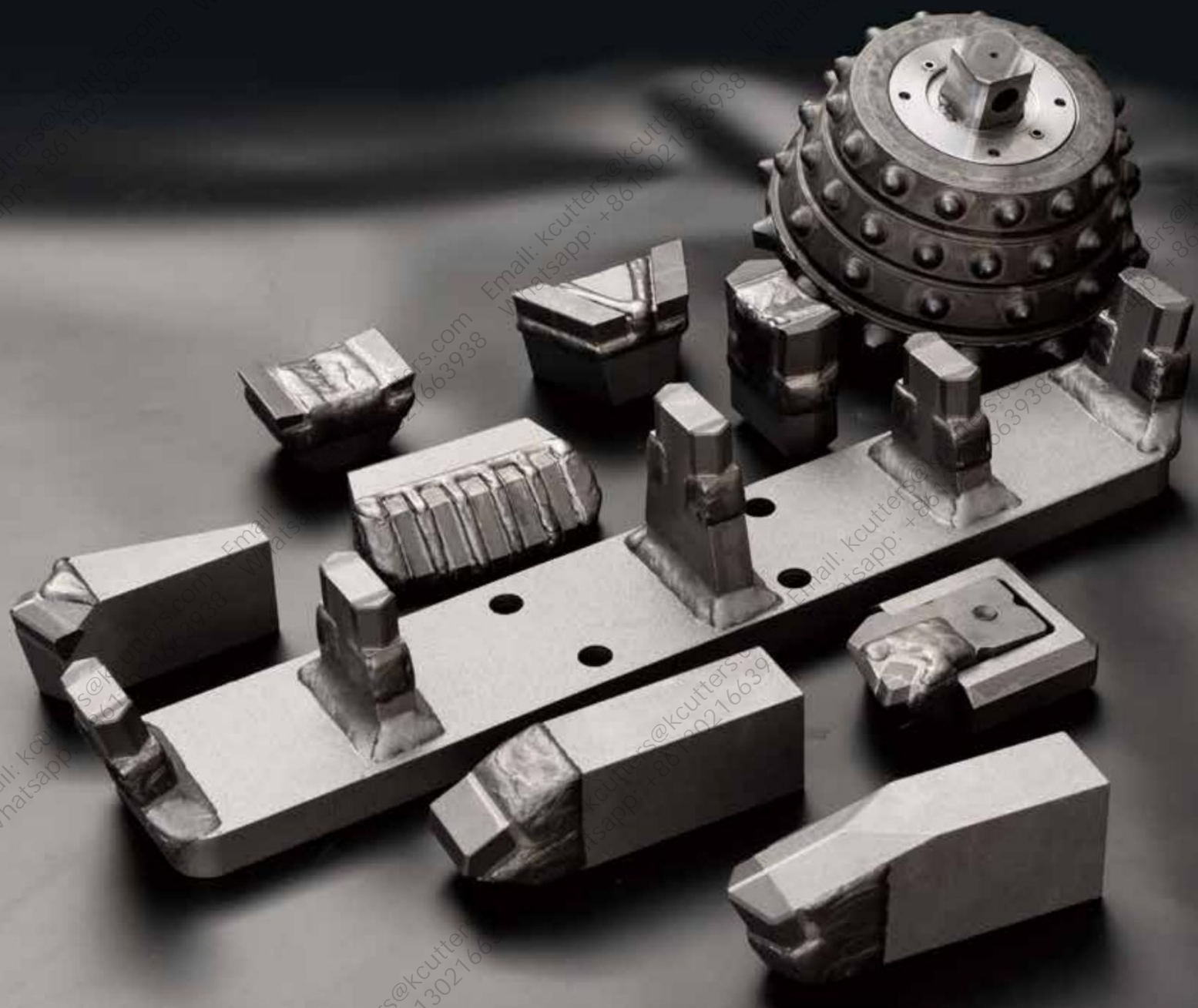

# 硬質合金工程刀具

CARBIDE CUTTING TOOLS FOR CIVIL CONSTRUCTION

桩机工程刀具/盾构刀具/矿山刀具/其他硬质合金工程刀具

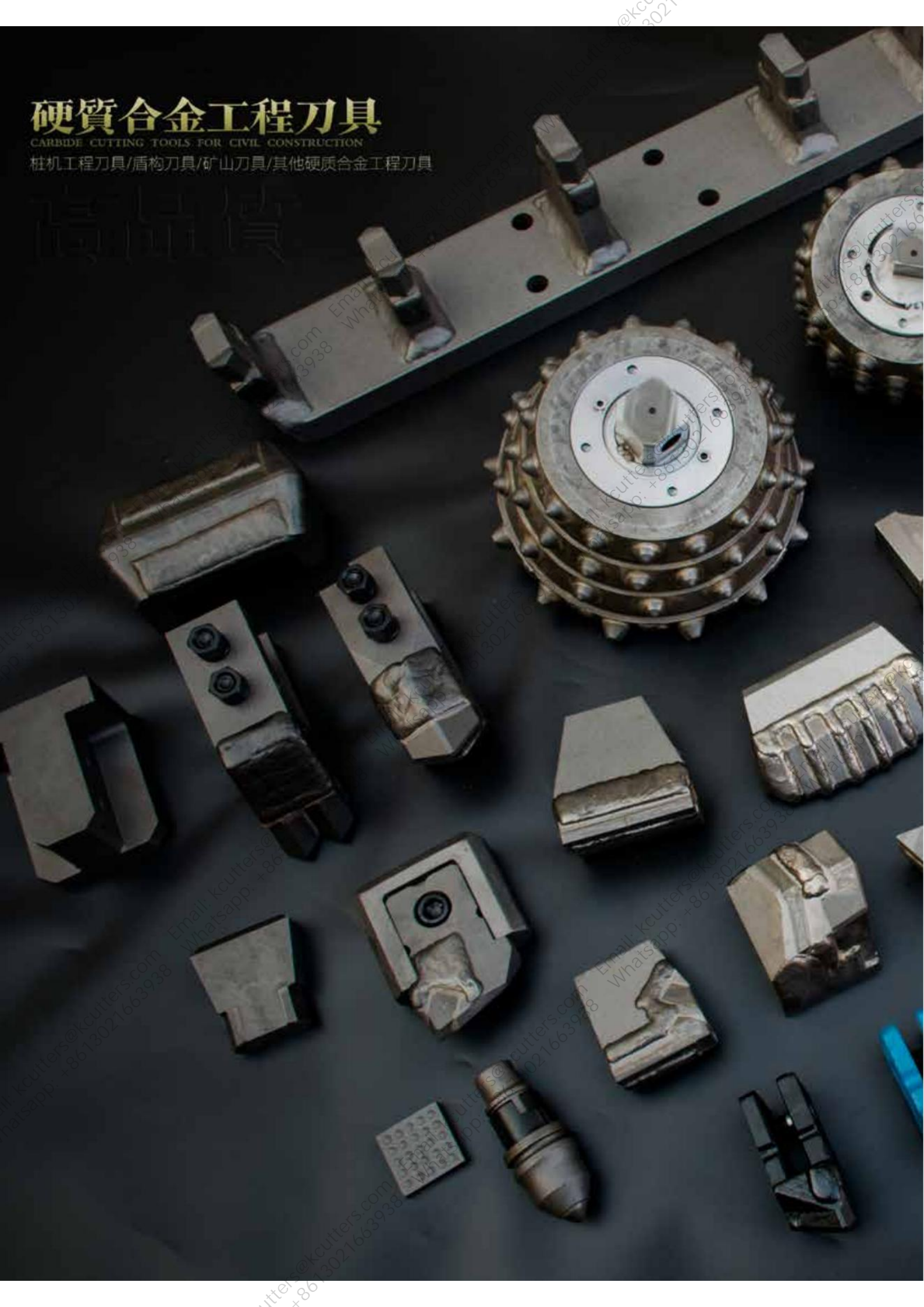



和諧創新 智造順造 高效共贏  
QINGDAO KAMOF ELECTRIC CO., LTD



攀越

巅峰

CLIMB THE PEAK

## 青岛卡莫夫电气有限公司 QINGDAO KAMOF ELECTRIC CO., LTD

Qingdao Kamof Electric Co., Ltd. is a company that develops and produces high-quality carbide engineering tools for infrastructure construction. The company is located in the beautiful seaside city of Qingdao, Shandong Province, China.

Our main products include full rotary casing machine tools, rotary drilling rig tools, pipe jacking machine welding tools and all kinds of pipe jacking machine hobs, shield machine welding tools and all kinds of hobs, cutter heads, and cutter rows for TRD construction, milling teeth for highway and mining, carbide nozzles for high-pressure rotary piles, all kinds of rock crushing tools, and tools for environmental protection crushing. They are widely used in various fields of infrastructure construction such as pile foundation railroads, highways, underground pipe networks, subway tunnels, mine, water conservancies, etc.

We strictly control product quality and are known for their demanding requirements. Provide the highest quality products. We have only one goal. Let us contribute to your business by winning your approval with our quality products!

We have only one goal: Let us win your approval with our quality products so that we can contribute our strength to your business!

# Product Catalog

# 欢迎

## Welcome

欢迎浏览本公司产品画册

### 盾构系列产品 Shield Cutter

焊接刀具 Welding Type	03
滚刀 Roller Bit	05

### 套管系列产品 Casing Bits

套管刀具 Casing Bit	09
内壁刀 Inner Blade	12
刀座 Casing Bit Holder	15

### 旋挖系列产品 Earth Auger Bits

焊接式 Welding Type	19
装卸式 Detachable type	21
刀座 Holder	23

### TRD 系列产品 TRD Bit

刀头 TRD Bit	27
刀排 Chain Cutter	27

### 高压旋喷硬质合金喷嘴

High Pressure Spin Spray Carbide Nozzle	
M/R/N/L/Special Type	29

### 截齿系列产品 Mining Bit

截齿 Mining Conical Drilling Bits	31
---------------------------------	----

### 其他产品 Others

双轮铣刀 Trench Cutter Teeth	33
斗齿 Bucket Teeth	
破碎刃 Crusher Blade	

Shield tunnel boring machine, is a kind of special large construction machinery used for tunnel boring.

It is widely used in underground passages, railroads, highways, municipalities, hydropower, and other tunneling projects. Shield cutter is a key supporting tool for shield machine tunneling, and its quality requirements are very high.

The shield cutters provided by our company are characterized by high strength, long service life, easy replacement, and convenient maintenance.

We provide professional production services for many partners.

# 盾構系列

Shield Cutter





# 焊接刀具

## Welding Type

- Manufactured by QINGDAO KAMOF ELECTRIC CO., LTD
- Shield cutters
- Welding type
- Products accept customization

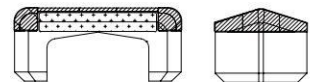
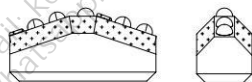
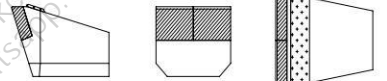
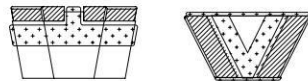
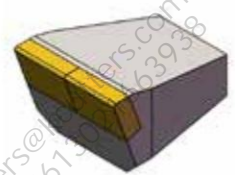
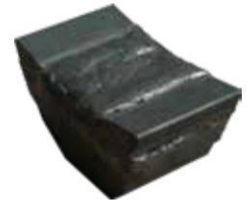





Products are suitable for all kinds of shield machinery, can be customized according to the user.

产品适用于各种盾构机械，可根据用户要求定制。

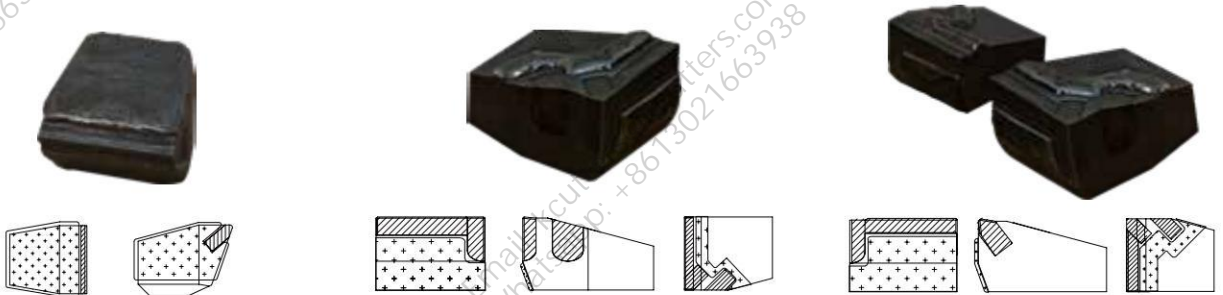
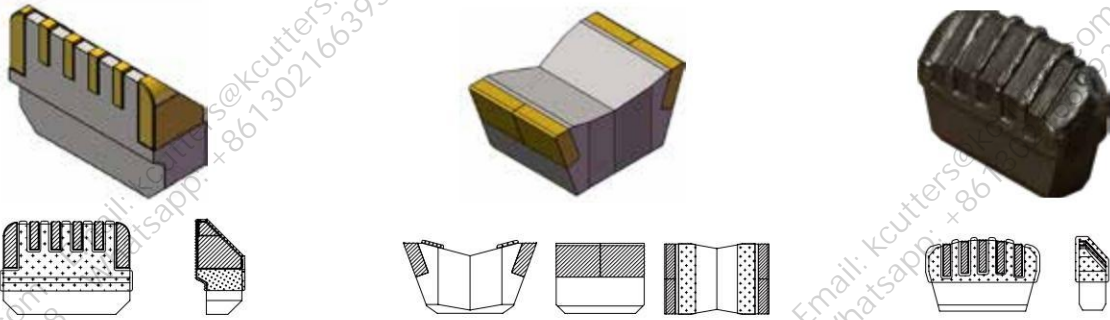



# 滚刀

Roller Bits

- Manufactured by QINGDAO KAMOF ELECTRIC CO., LTD
- Shield cutters
- Roller bits
- Products accept customization



本产品采用高硬度合金材料精制，通用各种盾构机械，可接受用户各种规格定制。



OPENFENXIN MACHINERY CO.,LTD

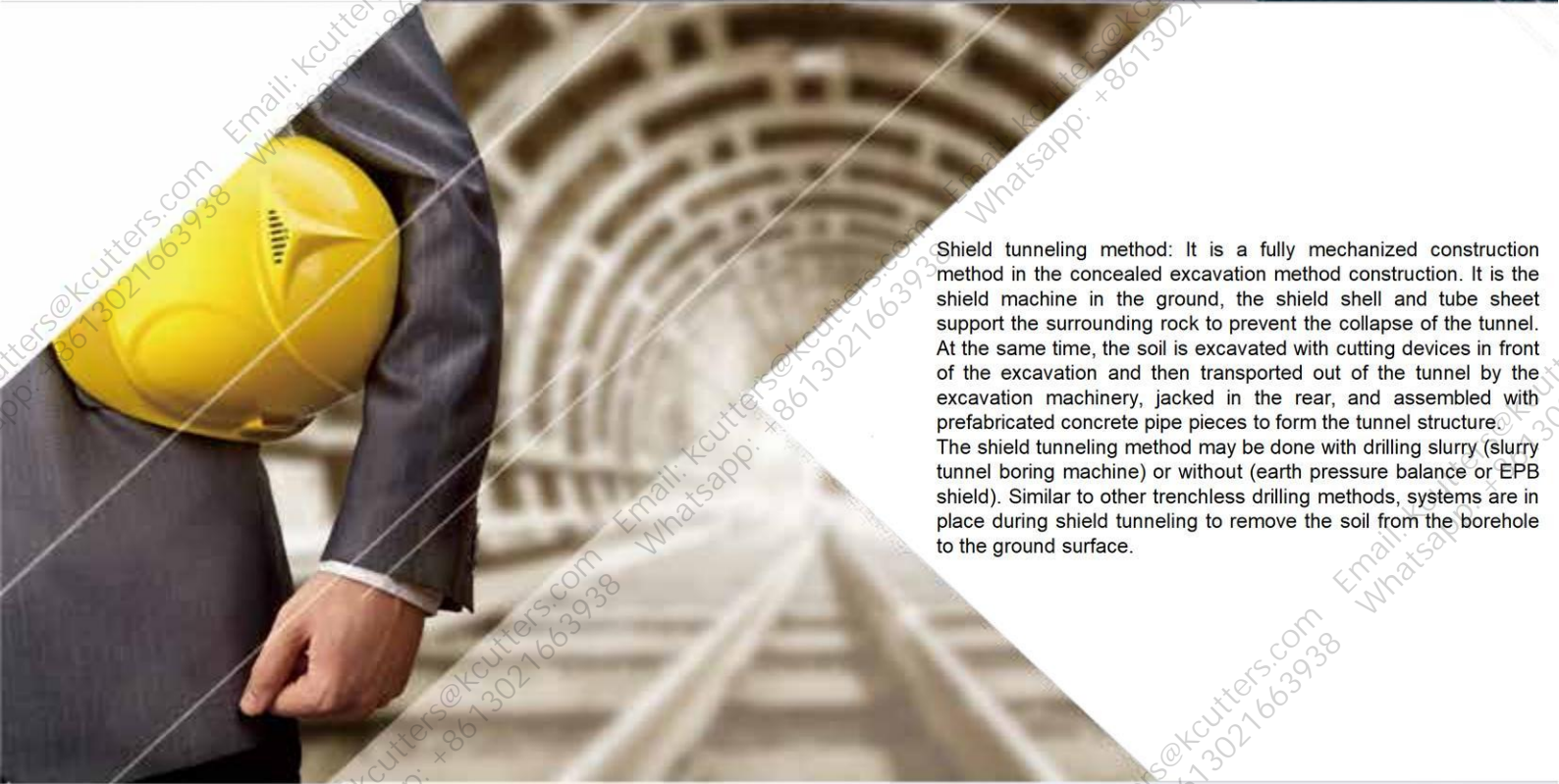

**Shield tunneling method:** It is a fully mechanized construction method in the concealed excavation method construction. It is the shield machine in the ground, the shield shell and tube sheet support the surrounding rock to prevent the collapse of the tunnel. At the same time, the soil is excavated with cutting devices in front of the excavation and then transported out of the tunnel by the excavation machinery, jacked in the rear, and assembled with prefabricated concrete pipe pieces to form the tunnel structure. The shield tunneling method may be done with drilling slurry (slurry tunnel boring machine) or without (earth pressure balance or EPB shield). Similar to other trenchless drilling methods, systems are in place during shield tunneling to remove the soil from the borehole to the ground surface.



The various shield machine cutters produced by our company are made of high carbide material. They have the characteristics of reasonable structure, high hardness, long service life, and easy installation. They are widely used in excavation projects under various geological conditions, such as railway and subway tunneling, highway tunneling, mine horizontal expansion, and other large earth and rock projects.





# 套管機系列

Casing Bits

# 全回转套管机刀具

## Casing Bits

- Manufactured by QINGDAO KAMOF ELECTRIC CO., LTD
- Casing teeth
- Type 40
- Products accept customization

刃型 Handed	型号 Cat No.	尺寸 (mm) 长 (L) × 宽 (W) × 高 (H)	适用刀座 Holder	形状 Outline Shape
	CB-40IRS-40H	120×43×80	CBH-40-M16	
	CB-40IRN-40H	118×43×80		
	CB-40IRU-40H	120×43×80		
	CB-40ILS-40H	120×43×80		
	CB-40ILU-40H	120×43×80		
	CB-40IRS-ST-40H	120×43×80		
	CB-40IRU-ST-40H	120×43×80		

- Manufactured by QINGDAO KAMOF ELECTRIC CO., LTD
- Casing teeth
- Type 50
- Products accept customization

刃型 Handed	型号 Cat No.	尺寸 (mm) 长 (L) × 宽 (W) × 高 (H)	适用刀座 Holder	形状 Outline Shape
	CB-50IRS-AG-40H	120×50×80	CBH-40-M16	
	CB-50IRU-AG-40H	120×50×80		
	CB-50IRS-50H	120×53×80	CBH-50-M16	
	CB-50IRU-50H	120×53×80		
	CB-50IRN-50H	118×53×80		
	CB-55IRS-AG-45H	120×55×80	CBH-45-M16	
	CB-55IRU-AG-45H	120×55×80		

# 全回转套管机刀具

Casing Bits

特殊型 special type

刃型 Handed	型号 Cat No.	尺寸 (mm) 长 (L) × 宽 (W) × 高 (H)	适用刀座 Holder	形状 Outline Shape
	CB-26IRS-05-26H	85×26×60	CBH-26-M16	
	CB-26IRU-05-26H	85×26×60		
	CB-35IN-26H	90×35×60		
	MB-40IRS-S	120×40×80		CBH-40-M16
	MB-40IRU-S	120×40×80		
	MB-40IRN-S	118×40×80		
	MB-40GS-AG	120×50×76		
	MB-40GU-AG	120×50×76		
	MB-40GN-AG	118×43×76		



# 全回转套管机内壁焊接刀

## Inner Bits

- Manufactured by QINGDAO KAMOF ELECTRIC CO., LTD
- Casing teeth
- Inner bits
- Products accept customization

刃型 Handed	型号 Cat No.	尺寸 (mm) 长 (L) × 宽 (W) × 高 (H)	形状 Outline Shape
	IB-30IN-W	142×30×60	
	IB-40IN-W	150×40×70	
	IB-50IN-W	160×50×80	
	IB-40IRS	150×40×60	
	IB-40IRU	150×40×60	
	IB-40IRN	150×40×60	
	IB-50IRS	160×50×70	
	IB-50IRU	160×50×70	

# 全回转套管机内壁焊接刀

## Inner Bits

- Manufactured by QINGDAO KAMOF ELECTRIC CO., LTD
- Casing teeth
- Inner bits
- Products accept customization

刃型 Handed	型号 Cat No.	尺寸 (mm) 长 (L) × 宽 (W) × 高 (H)	形状 Outline Shape
	IB-50IRN	160×50×70	
	IB-60IRS	170×60×80	
	IB-60IRU	170×60×80	
	IB-60IRN	170×60×80	
	IB-40IRS- 特	150×40×60	
	IB-60IRS- 特	170×60×80	
	IB-80IRS- 特	190×80×60	

- Manufactured by QINGDAO KAMOF ELECTRIC CO., LTD
- Casing teeth
- Inner bits
- Products accept customization

刃型 Handed	型号 Cat No.	尺寸 (mm) 长 (L) × 宽 (W) × 高 (H)	形状 Outline Shape
	IB-80IRS	190×80×100	
	IB-80IRU	190×80×100	
	IB-80IRN	190×80×100	
	IB-100IRS	200×100×100	
	IB-100IRU	200×100×100	
	IB-100IRN	200×100×100	
	IB-120IRS	220×120×140	
	IB-120IRU	220×120×140	
	IB-120IRN	220×120×140	

# 全回转套管机刀座

Holder

- Manufactured by QINGDAO KAMOF ELECTRIC CO., LTD
- Casing teeth
- Holder
- Products accept customization

刀座 Handed	型号 Cat No.	尺寸 (mm) 长 (L) × 宽 (W) × 高 (H)	形状 Outline Shape
	CBH-26-M16	70×26×65	
	CBH-40-M16	110×40×95	
	CBH-45-M16	110×45×95	
	CBH-50-M16	110×50×95	

## Cutter selection and assembly

Cemented Carbide Material Table						
Projects	Kamof Material	Hardness	Flexural strength	Abrasion resistance	Impact resistance	Color
		HRA	Gpa		Alloy chipping resistance	
For hard rock	ME 3	89	3.0 or above			Black ●
	ME 4	88	2.9 or above			Blue ●
For reinforced concrete	ME 5	87	2.7 or above			Yellow ●
For rolling stone	ME 6	86	2.7 or above			Green ●
Tool fixation direction		Fixed on the outside		Fixed on the inside		
Casing rotation direction		Turn right	Turn left	Turn right	Turn left	
Outer blade		CB-IRS	CB-ILS	CB-IRS	CB-ILU	
Middle blade		CB-IRN	CB-ILN	CB-IRN	CB-ILN	
Inner blade		CB-IRU	CB-ILU	CB-IRU	CB-ILS	
Assembly diagram						

## Scope of application

The full rotary drilling rig is not only used for pile foundation construction in various complex strata such as quicksand, karst terrain and super high backfill. It can also be used for the construction of bored secant piles, subway steel columns and pile extraction.

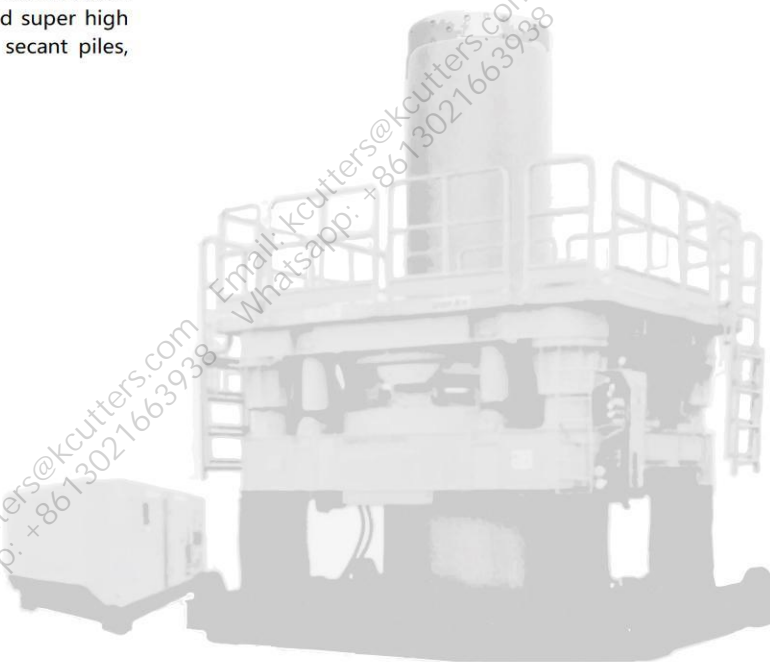







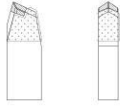

# 旋挖钻机焊接型刀具

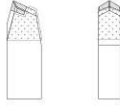
Earth Auger Bits

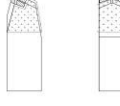
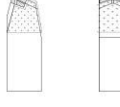
- Manufactured by QINGDAO KAMOF ELECTRIC CO., LTD
- Earth auger bits
- Welding type
- Products accept customization

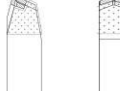
刃型 Handed	型号 Cat No.	尺寸 (mm) 长 (L) × 宽 (W) × 高 (H)	形状 Outline Shape
	AW-20K	215×20×70	
	AW-25K	215×25×70	
	AW-40K	200×40×70	
	AW-50K	215×50×70	
	AW-60K	220×60×80	
	AW-70K	230×70×100	
	AW-80K	250×80×110	

- Manufactured by QINGDAO KAMOF ELECTRIC CO., LTD
- Earth auger bits
- Welding type
- Flat type
- Products accept customization

刃型 Handed	型号 Cat No.	尺寸 (mm) 长 (L) × 宽 (W) × 高 (H)	形状 Outline Shape
	AW-25F	215×20×70	
	AW-40F	215×25×70	
	AW-50F	200×40×70	
	AW-60F	215×50×70	





# 旋挖钻机装卸型刀具

Earth Auger Bits

- Manufactured by QINGDAO KAMOF ELECTRIC CO., LTD
- Earth auger bits
- Detachable type
- Pointed type
- Products accept customization

刃型 Handed	型号 Cat No.	尺寸 (mm) 长 (L) × 宽 (W) × 高 (H)	形状 Outline Shape
	AH-40K-S	150×40×90	
	AH-50K-S	180×50×90	
	AH-60K-S	185×60×100	
	AH-80K-S	215×80×120	
	AH-60K-TS	180×60×100	
	AH-80K-TS	210×80×120	

- Manufactured by QINGDAO KAMOF ELECTRIC CO., LTD
- Earth auger bits
- Detachable type
- Flat Type
- Products accept customization

刃型 Handed	型号 Cat No.	尺寸 (mm) 长 (L) × 宽 (W) × 高 (H)	形状 Outline Shape
	AH-60F-TS	190×60×100	
	AH-80F-TS	215×80×120	

- Manufactured by QINGDAO KAMOF ELECTRIC CO., LTD
- Earth auger bits
- Detachable type
- W Type
- Products accept customization

刃型 Handed	型号 Cat No.	尺寸 (mm) 长 (L) × 宽 (W) × 高 (H)	形状 Outline Shape
	AH-60W-TS	190×60×100	
	AH-80W-TS	215×80×120	

# 旋挖钻机刀座

Earth Auger Holder

刃型 Handed	型号 Cat No.	尺寸 (mm) 长 (L) × 宽 (W) × 高 (H)	形状 Outline Shape
	ABH-40-TS	95×90×60	
	ABH-50-TS	130×90×60	
	ABH-60-TS	125×100×80	
	ABH-80-TS	140×120×105	
	ABH-60-S	140×100×80	
	ABH-80-S	180×120×105	

## CITY CONSTRUCTION

# 旋挖系列刀具

## Rotary Drilling Cutter Series

### Scope of application

The product is suitable for mining, highway construction, urban construction, infrastructure construction, and other large building construction.

## ROAD CONSTRUCTION

## MINE CONSTRUCTION

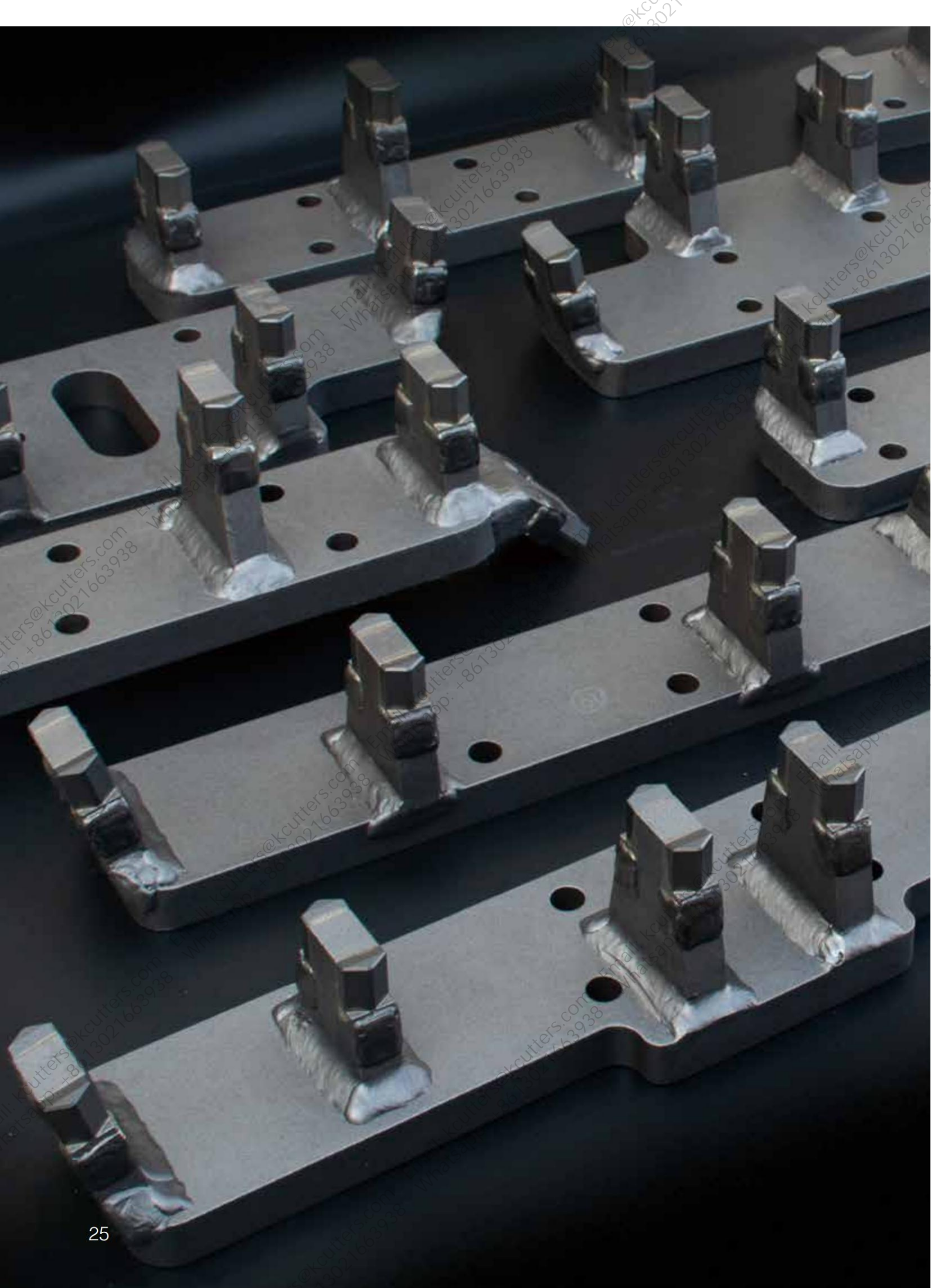



# TRD 系列

## TRD Series

# TRD

Standard



U type



- Manufactured by QINGDAO KAMOF ELECTRIC CO., LTD
- TRD cutters

TRD-03



TRD-04



TRD-05



TRD-09



TRD-10



TRD-11



Enhanced



TRD-01



TRD-02



TRD-06



TRD-07



TRD-08



TRD-12



TRD-13



TRD-14





# High-pressure spin spray carbide nozzle

- Manufactured by QINGDAO KAMOF ELECTRIC CO., LTD
- High-pressure spin spray carbide nozzle
- M-type nozzle

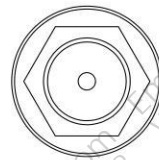
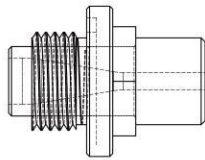

M-type	NO.	1	2	3	4	5	6	7	8	9	10	11
	Diameter	2.2	2.4	2.6	2.8	3.0	3.2	3.5	3.8	4.0	4.2	4.4

## M-Special type

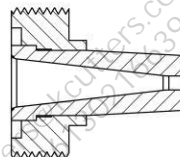
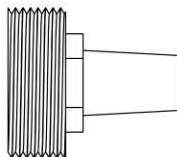
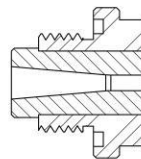
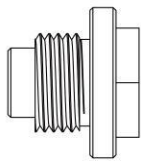

- Manufactured by QINGDAO KAMOF ELECTRIC CO., LTD
- High-pressure spin spray carbide nozzle
- R-type nozzle

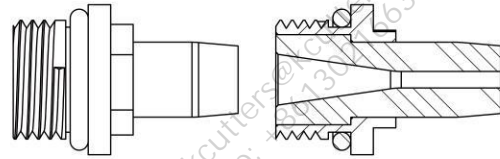
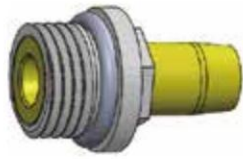

R-type	NO.	1	2	3	4	5	6	7	8	9	10
	Diameter	1.8	2.0	2.2	2.3	2.4	2.6	2.8	3.0	3.1	3.2
	NO.	11	12	13	14	15	16	17			
	Diameter	3.5	3.8	4.0	4.2	4.5	4.8	5.0			

- Manufactured by QINGDAO KAMOF ELECTRIC CO., LTD
- High-pressure spin spray carbide nozzle
- L-type nozzle

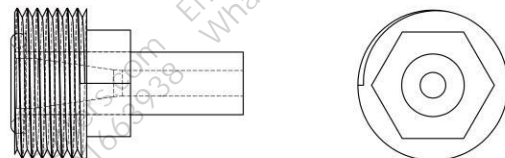
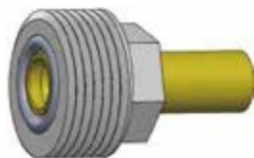

L-type	NO.	1	2	3	4	5	6	7
	Diameter	3.0	3.3	3.8	4.1	5.0	6.0	7.0

# Mining Conical Drilling Bits



KB-38-92L



KB-35-80L



KB-50K-127L



KB-6022L

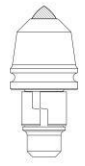

KB-5022-H

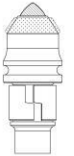

KB-5019L-H



KB-5017L



KB-5017L-1



KB-2507L



KB-2508L

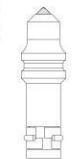

KB-2516L



TRD-C30W

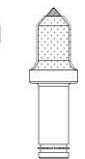

# How to choose cutting pick

Cutting pick is mainly used in coal mining machines, tunneling machines, and some excavators and milling machines may also use cutting pick. However, different machine models and different construction environments require different cutting pick models. So, what are the commonly used cutting pick models? And what kind of working conditions and machines are they suitable for?

There are two types of commonly used cutting picks, S-type and U-type.

S-type cutting picks are mostly used in tunneling machines, and the sub types include S100, S135, S120, etc. These cutting picks are suitable for construction environments such as coal rock tunnels, soft rock tunnels, highway tunnels, railway tunnels, etc. It is worth mentioning that the shape of the cutting pick used in tunneling machines is pick-shaped, mostly made of high-hardness alloy steel, and the service life of this type of cutting pick depends on the material of the alloy head, welding quality, working conditions, etc.

U-type cutting picks are used on coal mining machines, and there are more than ten specific types, such as U84, U170, U95, etc. Moreover, according to different working conditions, cutting picks for coal mining machines are also divided into ordinary type, hard rock type, sandstone type, etc. These cutting picks have undergone special processing in the production process, such as adding alloy bars to sandstone-type cutting picks, adding wear-resistant layers to wear-resistant cutting picks, and using plasma technology to add wear-resistant alloy materials to spark-free cutting picks.

Therefore, when selecting cutting picks, construction personnel must first understand their construction environment and machine models, and then match them with appropriate cutting picks.



# More Products

- Manufactured by QINGDAO KAMOF ELECTRIC CO., LTD
- Double Wall Trench Cutter Teeth For Wheel Trencher

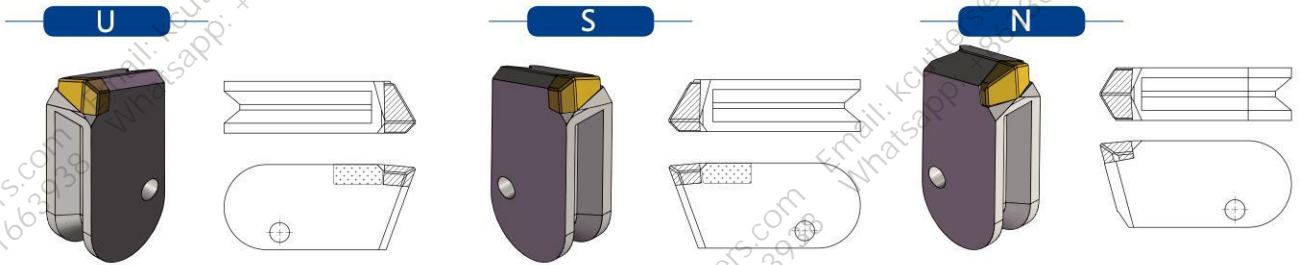

- Manufactured by QINGDAO KAMOF ELECTRIC CO., LTD
- Bucket teeth

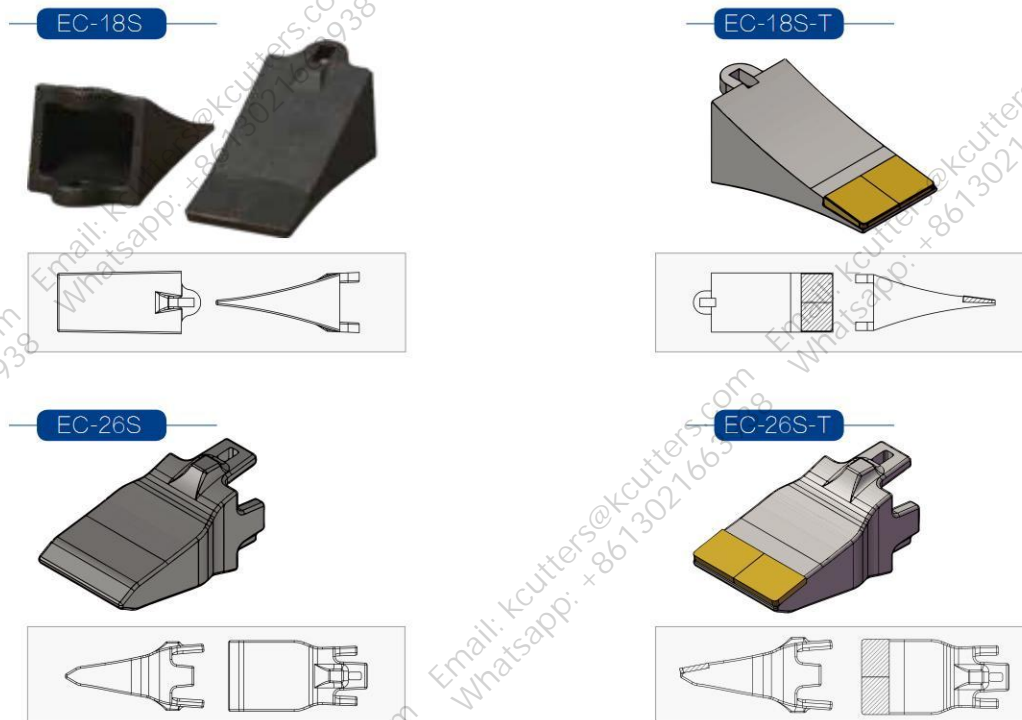

- Manufactured by QINGDAO KAMOF ELECTRIC CO., LTD
- Crusher blade



● Shredder blade

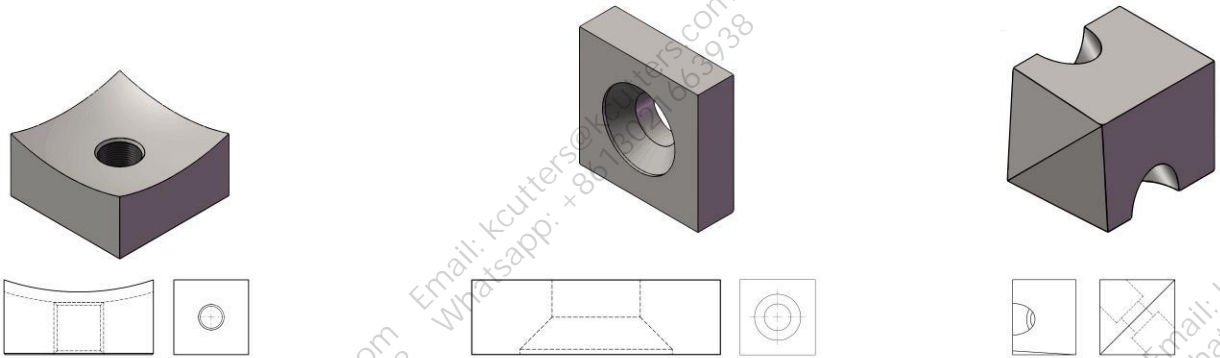

● Single shaft shredder bottom knife blade

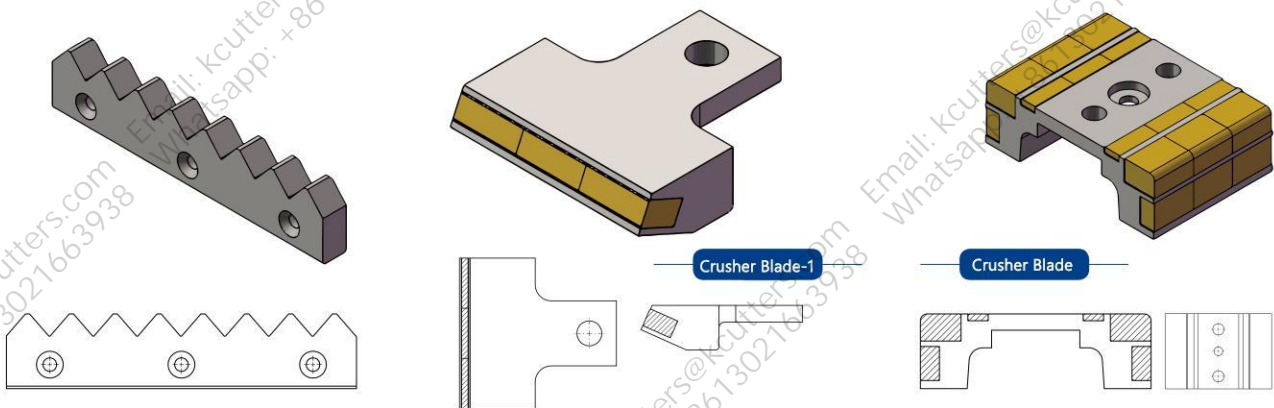

Our company can customize various specifications of carbide engineering tools according to customers' drawings.



## Why work with Kamof

- 理念 idea

Kamof adheres to the company's development purpose of honesty, treats people with sincerity, casts the industry with sincerity, and makes every product with sincerity. We are committed to the concept of technology first and quality first, and we are deeply engaged in the manufacturing technology of cemented carbide engineering tools, and we provide high-quality products with our craftsmen's feelings.

- 设计 design

Excellence comes from professional design. We know that the quality of our products and the efficacy of the real-world applications are the key to providing the best design solutions. Therefore, we set up a first-class design team, in reference to the international advanced design, while trying to innovate, and strive to provide the best design solutions to create a better product.

- 制造 Manufacturing

Our company trains young and excellent employees as the core of production, constantly improving production skills and manufacturing high-quality products. We encourage and support them to be innovative, and give them great rewards to make them more responsible and enterprising. Thus, we can guarantee the quality of our products. We have several quality inspection procedures for every product we manufacture to ensure the quality of our products. Before shipment, the production manager is responsible for re-inspection to ensure that the products are delivered to customers. The quality of our products is qualified and all of them are excellent.

# 合作共赢

COOPERATION  
WIN SITUATION

- **高效率 High Efficiency**

A full set of high-end imported production equipment to form an automated production, to ensure the quality of the premise, and greatly shorten the production cycle to meet the customer's requirements on time. The company is located in the new development area, with a convenient geographical transportation environment, air, rail, highway, shipping multiple transportation methods can be convenient and rapid delivery of products in the shortest time to your hands.

- **技术支持 Technical Support**

We not only provide you with high-quality products but also with the best solutions.

In order to solve the difficulties of customers in the actual application, we are ready to provide you with the best solutions to solve your problems. We help customers to solve the problems and difficulties encountered in the actual application, so as to maximize the value of our products. We can develop well only when our customers develop well. Only in this way will we have lasting cooperation and development.

Email:kcutters@kcutters.com

Whatsapp:+8613021663938